



BEYOND EXPECTATIONS.

ELIOS™
ELIOS™



Experience Elios – it's architectural
and cinema audio on a whole new level.

ONLY BY

ELAN®
elanhomesystems.com

ELIOS™

CINEMA & ARCHITECTURAL S P E A K E R S

THE EVOLUTION OF ARCHITECTURAL AUDIO

For years, in-wall and in-ceiling speakers were thought of as an acceptable lower-cost, lesser-quality alternative to free-standing speakers for homeowners who wanted their music heard, but not seen, throughout the house.

Over the years, things have changed significantly in the speaker arena. Digital audio has brought crystal-clear portable sound directly to the ears of millions. Expectations of what people want to hear in the confines of their homes – whether in the bedroom, kitchen, bathroom or garage – have grown. Whole-house audio is no longer background music, and discriminating listeners expect more.

Elios™ has been carefully developed in direct response to these higher expectations.

Like homeowners, the expectations of the Custom Audio/Video Contractor have also grown. Although sound quality has become a major selling point, durability of materials and ease of installation have become every bit as important – adding more to a Dealer's bottom line by reducing breakage and installation time. Standing high up on a ladder with a screw gun in one hand and a speaker in the other is not the time to discover you need a third hand. Professional installers expect and deserve more.

Elios is a direct response to the Dealer's ever-evolving needs and requirements.

DESIGNED AND BUILT WITH AN UNDERSTANDING OF THE APPLICATIONS

Great speakers are much more than the sum of their parts. Technologically advanced cone materials and computer-designed crossover networks are of little value if the end result is a speaker that is difficult to install and unpleasing to the ears.

The Elios line of Architectural and Cinema In-Wall and In-Ceiling Speakers were designed and built with an understanding of all the applications. The most technologically advanced cone materials have been used for all drivers as well as the aid of a computer when designing our crossover networks. But that was only the beginning.

Taking the holistic approach, our guiding tenet when developing Elios was that a whole system of values must be analyzed rather than simply its individual components. Everything from the exacting needs of the installer to the discriminating ear of the listener must be carefully and thoroughly considered if we were to take architectural audio to a completely new level.

Our research shows that most people we know don't listen to music in an acoustically-perfect sound lab. They listen while lying in bed, or standing at the kitchen counter, or while taking a bath. In addition to using anechoic chamber measurements to aid in the design, every Elios speaker was voiced under real-life listening conditions – in a real room with real furniture and real pictures hanging on the wall.

Most of the Custom Audio/Video Contractors we know don't install architectural speakers in a test lab with free-standing drywall platforms and pre-cut ceiling tiles. Every Elios speaker was installation-tested under real-life installation conditions – in a real home with real walls and high ceilings.

At ELAN, we felt it was about time that expectations were met like never before.

Introducing ELIOS — designed to meet your highest expectations.



DESIGN FEATURES FOR THE CUSTOM INSTALLER

All Elios Speaker models, regardless of price, include innovative new features that make their installation easier, less time-consuming and perfect each time.

EASY-STAY GRILLES

Built and tested with the Custom Installer in mind, the unique baffle and frame design of every Elios speaker ensures that grilles will always go on easily and always stay in place.

EASY-RELEASE CLAMPING LEGS

New, specially designed leg towers and caps mean no more stuck or broken clamping legs, stripped

screws and exposed screw tips. The new high-strength design of the legs means they won't break, and the larger footprints mean less pressure on the drywall and therefore less crushing around the cutout.

EASY-CUT FLANGES

Not too narrow, not too wide – All Elios speakers feature flange widths that are wide enough to cover inconsistencies in the drywall cutout, yet narrow enough to keep a sleek in-wall/in-ceiling appearance.

EASY-PAINT BEZELS

Special care was taken to select the right plastic (ABS 757) to allow for a wide range of paints to properly adhere to it. This includes eco-friendly water based enamel paints.

EASY-CATCH DEBRIS SCREENS

All woofer frames have built-in debris screens to prevent damage to the woofer cone during installation and while home construction is still going on.

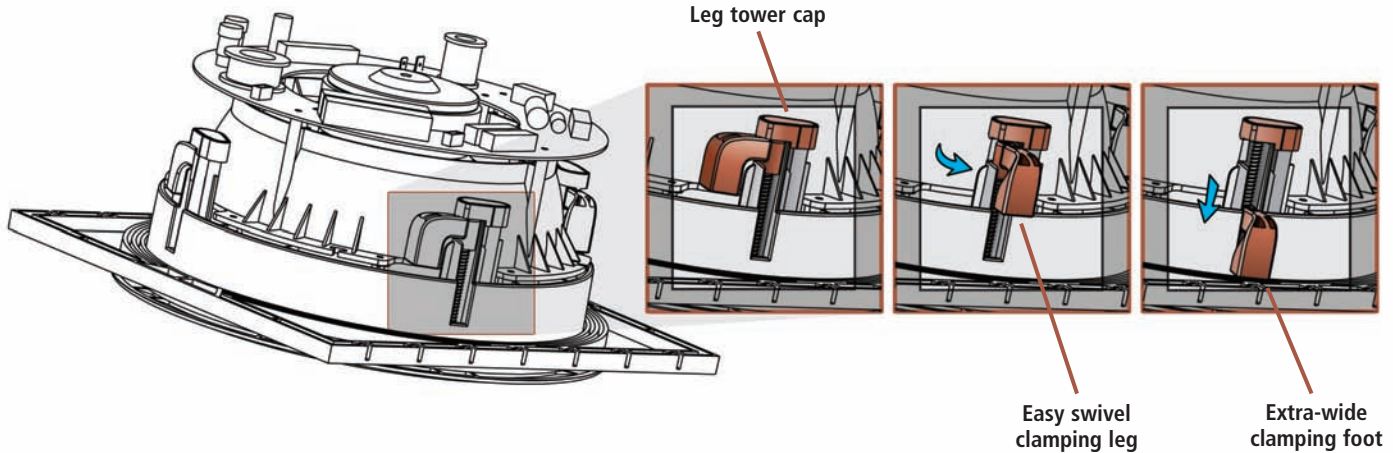

DESIGN FEATURES FOR THE AUDIO ENTHUSIAST

Fine-tuned in real life listening environments, all ELIOS speakers deliver uncompromised sound.

1" TWEETER / 7" WOOFER 2-WAY SPEAKER DESIGN

In general, the larger the woofer the more difficult it is to use in a 2-way (woofer/tweeter) system. Our choice of 1-inch tweeters on all 7-inch models (except dual voice coil) means a smooth summation through the critical vocal region. 1-inch tweeters also have greater power-handling than 3/4-inch tweeters. This is very important in 2-way speakers systems as we can confidently lower the crossover point, which in turn makes for a more natural sound through that same vocal range.

3/4" TWEETER / 9" WOOFER 3-WAY SPEAKER DESIGN

With the addition of a midrange driver in a 3-way speaker system, tweeters are not required to reproduce the lower frequencies that are needed

to make them blend properly in a 2-way speaker design. This means that they do not need to handle as much power, and that the overall system can handle more power. We therefore chose to go with 3/4-inch tweeters in our 3-way systems in order to take advantage of their superior dispersion characteristics which blend perfectly with the 2.5-inch midrange and 9-inch woofer for smoother on- and off-axis response.

CUSTOM CROSSOVER NETWORKS

Compared to most other brands, Elios speakers use higher power-handling components for their crossover networks. The Elios Cinema line of speakers takes it a step further with the use of high-quality inductors and Mylar and polypropylene capacitors. All these contribute to less distortion and higher sound quality.

Additionally, Elios crossover networks are not designed in a vacuum. Only after careful consideration of the drivers and mechanical design of each speaker are just the right components selected to get the response or sound we want. This completely integrated approach to crossover design, combined with optimization software and

a ton of listening, make all Elios speakers a cut above the rest.

DIRECTIONAL SOUND

Elios speakers use both pivoting and rotational mechanisms that allow you to direct the sound into the listening area. This results in greatly enhanced stereo imaging regardless of speaker placement or room dimensions.

BIGGER MAGNETS

Bigger magnets on each woofer means more output and a punchier bottom end. Bigger magnets are common in box speakers where depth constraints aren't an issue. The magnets on architectural speakers, by their very nature, are restricted by where they are being installed. All Elios speakers have been custom engineered to allow for bigger magnets with woofer motors specifically designed for in-wall/in-ceiling applications.

DESIGNED FOR A LIFETIME OF USE
All Elios speakers come with a Limited Lifetime Warranty.

ELIOS ARCHITECTURAL & CINEMA SPEAKERS

Elios Architectural Speakers

7" In-Ceiling w/ stationary woofers

Rough-In Bracket

E70C MSRP: \$200.00/pr. E71C MSRP: \$250.00/pr. E72C MSRP: \$300.00/pr. E72D MSRP: \$200.00/ea. BKT7C

7" In-Ceiling w/ pivoting woofers

E73C MSRP: \$400.00/pr. E74C MSRP: \$500.00/pr. E75C MSRP: \$600.00/pr. E73D MSRP: \$325.00/ea. BKT7PC

7" In-Walls

E71W MSRP: \$250.00/pr. E72W MSRP: \$300.00/pr. BKT7W

Elios Cinema Speakers

9" In-Ceiling w/ stationary baffles

E91C MSRP: \$300.00/ea. E92C MSRP: \$375.00/ea. BKT9C

9" In-Ceiling w/ rotating baffles

E93C MSRP: \$500.00/ea. E94C MSRP: \$625.00/ea. E95C MSRP: \$750.00/ea. BKT9PC

Dual 5.25" In-Wall

E552W MSRP: \$500.00/ea. E532W MSRP: \$325.00/ea. BKT55W E650S MSRP: \$430.00/ea

Dual 7" In-Wall

E752W MSRP: \$750.00/ea. BKT77W

ELIOS ARCHITECTURAL SPEAKERS

IN-CEILING • IN-CEILING DUAL VOICE COIL • IN-WALL

Introducing the Elios line of Architectural Speakers – ten in-wall and in-ceiling speaker models designed to meet the exacting needs of Homeowner and Custom Installer alike.

ARCHITECTURAL CEILING SPEAKERS

Elios Architectural Ceiling Speakers feature a 2-way design that optimizes the use of custom 7-inch woofers and 1-inch pivoting tweeters.

1-inch tweeters have greater power handling. This is very important in 2-way speaker systems as we can confidently lower the crossover point, allowing the tweeters to blend better with the large 7-inch woofer. This makes for a more

natural sound through the critical vocal range, while leaving the detail of the high frequencies and the punchy bottom end in tact.

The Elios line features six 2-way Architectural Ceiling Speakers that provide you and your clients with the quality sound, uncompromising construction and flexible price points needed for today's multi-room audio applications.

Elios E75C / E74C / E73C

Designed for critical, frequently-used listening areas, these three in-ceiling models offer exceptional bass, beautiful vocal range response and some of the most accurate, natural-sounding highs you'll ever hear.

What's more, the E75C, E74C & E73C deliver stereo imaging rivaling that of perfectly positioned cabinet speakers by placing both the tweeter and the woofer in a pivoting baffle design that enables you to direct the entire frequency spectrum toward the prime listening area.

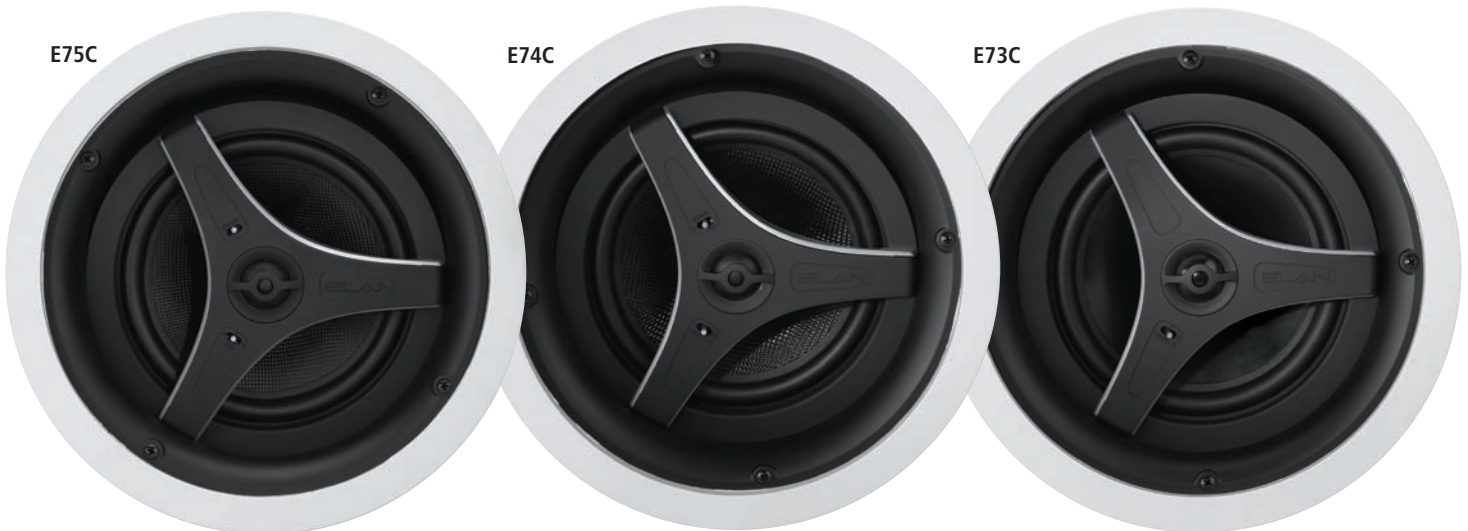

	E75C	E74C	E73C
Woofer	7 in. Kevlar, pivoting	7 in. fiberglass, pivoting	7 in. Mica-filled injection cone, pivoting
Tweeter	1 in. Titanium / Aluminum nano-coated Teteron dome, pivoting	1 in. Titanium / Aluminum nano-coated Teteron dome, pivoting	1 in. Teteron Dome, pivoting
Frequency Response	45Hz-20kHz	45Hz-20kHz	48Hz-20kHz
Sensitivity	88.5dB	88dB	87.5dB
Rated Power	65W RMS	65W RMS	60W RMS
Nominal Impedance	8 Ohms	8 Ohms	8 Ohms
Crossover	Enhanced Custom "Q" multi-pole	Enhanced Custom "Q" multi-pole	Custom "Q" multi-pole
Switches	Bass & EQ	Bass & EQ	EQ
Cutout Dims.	9-3/4 in. (246.5 mm)	9-3/4 in. (246.5 mm)	9-3/4 in. (246.5 mm)
Outside Frame Dims.	11 in. (279 mm)	11 in. (279 mm)	11 in. (279 mm)
Depth	5-7/8 (148mm)	5-7/8 (148mm)	5-7/8 in. (148 mm)
Rough-in Brackets	BKT7PC	BKT7PC	BKT7PC

ELIOS ARCHITECTURAL SPEAKERS continued

---Elios E72C / E71C / E70C

For rooms where the finest sound is still a prerequisite but the listening area is more fluid (i.e. the kitchen or rec room), Elios in-ceiling models E72C, E71C and E70C feature a stationary woofer baffle and a pivoting tweeter that allows high-frequencies to be directed into the listening area.

Combined with all of Elios' unique design innovations that make installation easy and trouble-free every time, the result is three beautiful-sounding, easy-to-install ceiling speakers that shine in any application and fit perfectly into any budget.



E72C

E71C

E70C

Woofer	7 in. Mica-filled injection cone	7 in. mineral-filled Polypropylene	7 in. mineral-filled Polypropylene
Tweeter	1 in. Silk Dome, pivoting	1 in. Soft Dome, pivoting	3/4 in. Soft Dome, pivoting
Frequency Response	50Hz-20kHz	50Hz-20kHz	50Hz-20kHz
Sensitivity	87dB	87dB	87dB
Rated Power	55W RMS	50W RMS	50W RMS
Nominal Impedance	8 Ohms	8 Ohms	8 Ohms
Crossover	Custom "Q" multi-pole	Custom "Q" multi-pole	Custom "Q" single pole
Switches	High Freq.	N/A	N/A
Cutout Dims.	8-5/8 in. (220 mm)	8-5/8 in. (220 mm)	8-5/8 in. (220 mm)
Outside Frame Dims.	10 in. (253 mm)	10 in. (253 mm)	10 in. (253 mm)
Depth	4-3/8 in. (111 mm)	4-1/4 in. (108 mm)	4-1/4 in. (108 mm)
Rough-in Brackets	BKT7C	BKT7C	BKT7C

ELIOS ARCHITECTURAL SPEAKERS continued

ARCHITECTURAL DUAL VOICE COIL CEILING SPEAKERS Elios E73D / E72D

Dual voice coil speakers are designed to provide stereo sound and imaging in areas where only one speaker can be installed. Elios Dual Voice Coil Speakers are designed to provide THE BEST stereo sound and imaging possible from a single speaker.

Utilizing dual 3/4" tweeters to maximize high-end dispersion, 7-inch mica-filled injection cone woofers and a custom crossover network, both models provide impressive high/mid stereo imaging and exceptional bass. The E73D also features a pivoting "eyeball" mechanism that allows the sound to be directed into the listening area for even better imaging.

Just because space is at a premium doesn't mean you have to compromise on premium sound!



E73D



E72D

E73D

E72D

Woofers	7 in. Mica-filled injection cone, pivoting	7 in. Mica-filled injection cone
Tweeter	(2) 3/4 in. Teteron Dome	(2) 3/4 in. Soft Dome
Frequency Response	48Hz-20kHz	50Hz-20kHz
Sensitivity	88dB	87dB
Rated Power	60W RMS	55W RMS
Nominal Impedance	8 Ohms	8 Ohms
Crossover	Custom "Q" multi-pole	Custom "Q" multi-pole
Switches	EQ	High Frequency
Cutout Dims.	9-3/4 in. (247 mm)	8-5/8 in. (220 mm)
Outside Frame Dims.	11 in. (279 mm)	10 in. (253 mm)
Depth	6-3/4 in. (171mm)	4-3/8 in. (111 mm)
Rough-in Brackets	BKT7PC	BKT7C

ELIOS ARCHITECTURAL SPEAKERS continued

ARCHITECTURAL IN-WALL SPEAKERS

Elios E72W / E71W

For applications where only in-wall speakers will do, Elios has two high-performance models with 7-inch woofers and pivoting 1-inch tweeters that deliver full, rich, accurate sound to even the largest of rooms.

Special care was taken on our in-wall models to minimize tweeter diffraction. This makes for a smoother high frequency response and a better sounding speaker.

Like the in-ceiling models, 1-inch tweeters in pivoting “eyeballs” are matched perfectly to blend with 7-inch woofers and custom crossover networks to provide warm, natural-sounding vocal reproduction, clear high end and deep bass.

E72W



E71W



E72W

E71W

Woofers	7 in. Mica-filled injection cone	7 in. mineral-filled Polypropylene
Tweeter	1 in. Soft Dome, pivoting	1 in. Soft Dome, pivoting
Frequency Response	50Hz-20kHz	50Hz-20kHz
Sensitivity	87.5dB	87dB
Rated Power	55W RMS	50W RMS
Nominal Impedance	8 Ohms	8 Ohms
Crossover	Custom “Q” multi-pole	Custom “Q” multi-pole
Switches	High Frequency	N/A
Cutout Dims.	7-7/8 W x 13-1/2 H in. (201 W x 342 H mm)	7-7/8 W x 13-1/2 H in. (201 W x 342 H mm)
Outside Frame Dims.	9-1/4 W x 14-3/4 H in. (234 W x 375 H mm)	19-1/4 W x 14-3/4 H in. (234 W x 375 H mm)
Depth	3-7/8 in. (97 mm)	3-7/8 in. (97 mm)
Rough-in Brackets	BKT7W	BKT7W

ELIOS CINEMA SPEAKERS

PREMIUM IN-WALL & IN-CEILING SPEAKERS FOR THE HOME THEATER

Introducing the Elios line of Cinema Speakers – seven in-wall and in-ceiling speaker models specifically designed to reproduce the dynamic, high-end audio required for Home Theater environments.

CINEMA CEILING SPEAKERS

Elios Cinema Speakers take in-ceiling Home Theater sound reproduction to the next level.

All five models are of a 3-way design that features custom 9-inch woofers with larger magnets for increased output and tighter bottom end. The 2.5-inch midrange and 3/4" tweeter are mounted on a bridge with a fixed 30° angle from the woofer's audio axis.

This not only allows you to point the mids and highs into the listening area for better imaging, but ensures that the midrange driver's lower frequencies are isolated from the upper frequencies of the woofer's spectrum, making for smooth and articulate vocal reproduction. Additionally, the tweeters pivot independently of the bridge, allowing for even more pin-point accuracy of upper frequencies.

Featuring five 3-way models, the Elios line of Cinema Ceiling Speakers deliver sound and imaging that defy their in-ceiling nature.

Designed for front stage, center stage, surround sound or any in-ceiling application where audio is taken very seriously, Elios Cinema Ceiling Speakers succeed on every level.

Elios E95C / E94C / E93C

Our three flagship models, the E95C, E94C and E93C take this concept a step further with a fully rotating baffle design that makes installation and high frequency steering incredibly simple and accurate.

Quite simply, this is in-ceiling sound at its very, very best.

ELAN's Flagship Model



	E95C	E94C	E93C
System Type	3-way bridge design, 360° rotating baffle	3-way bridge design, 360° rotating baffle	3-way bridge design, 360° rotating baffle
Woofer	9 in. Kevlar	9 in. fiberglass	9 in. Mica-filled injection cone
Midrange	2.5 in. Kevlar	2.5 in. fiberglass	2.5 in. Mica-filled injection cone
Tweeter	3/4 in. Titanium / Aluminum nano-coated Teteron dome, pivoting	3/4 in. Titanium / Aluminum nano-coated Teteron dome, pivoting	3/4 in. Teteron dome, pivoting
Frequency Response	40Hz-20kHz	40Hz-20kHz	43Hz-20kHz
Sensitivity	88.5dB	88dB	87.5dB
Rated Power	90W RMS	90W RMS	85W RMS
Nominal Impedance	8 Ohms	8 Ohms	8 Ohms
Crossover	Custom "Q" multi-pole	Custom "Q" multi-pole	Custom "Q" multi-pole
Switches	Bass & EQ	Bass & EQ	EQ
Cutout Dims.	12-5/8 in. (320 mm)	12-5/8 in. (320 mm)	12-5/8 in. (320 mm)
Outside Frame Dims.	13-7/8 in. (353 mm)	13-7/8 in. (353 mm)	13-7/8 in. (353 mm)
Depth	6-1/2 in. (165 mm)	6-1/2 in. (165 mm)	6-1/2 in. (165 mm)
Rough-in Brackets	BKT9PC	BKT9PC	BKT9PC

ELIOS CINEMA SPEAKERS continued

Elios E92C / E91C

Home Theaters vary in magnitude and use. The requirements and expense of a surround sound system in the bedroom or playroom may not be the same as a home's main theater room.

Still, there's no need to sacrifice sound and imaging just because you're watching a movie in bed. The Elios E92C and E91C were designed to impress the ears and your clients' budget.



E92C



E91C

E92C

E91C

System Type	3-way bridge design, stationary baffle	3-way bridge design, stationary baffle
Woofers	9 in. Mica-filled injection cone	9 in. mineral-filled Polypropylene
Midrange	2.5 in. Mica-filled injection cone	2.5 in. mineral-filled Polypropylene
Tweeter	3/4 in. silk dome, pivoting	3/4 in. soft dome, pivoting
Frequency Response	45Hz-20kHz	45Hz-20kHz
Sensitivity	87dB	87dB
Rated Power	80W RMS	75W RMS
Nominal Impedance	8 Ohms	8 Ohms
Crossover	Custom "Q" multi-pole	Custom "Q" multi-pole
Switches	High Frequency	N/A
Cutout Dims.	10-7/8 in. (275 mm)	10-7/8 in. (275 mm)
Outside Frame Dims.	12-1/8 in. (308 mm)	12-1/8 in. (308 mm)
Depth	6-3/4 in. (171 mm)	6-3/4 in. (171 mm)
Rough-in Brackets	BKT9C	BKT9C

ELIOS CINEMA SPEAKERS *continued*



E752W

Elios E752W / E552W / E532W

Using a finely-tuned array of dual woofers, pivoting dome tweeters and custom “Q” multi-pole crossover networks, Elios Cinema In-Walls produce beautiful imaging and sonic excellence across the entire frequency spectrum.

The E752W and E552W both use dual woven Kevlar woofers and nano-coated Teteron dome pivoting tweeters to deliver incredible bottom-end punch and the cleanest, most natural-sounding high-end reproduction of any in-wall speaker you’ll encounter.

The E552W and E532W feature ELAN’s patent-pending 15° angled baffle, making them two of the most flexible Home Theaters speakers on the market. Ideal as a left or right stage speaker that can focus sound into the listening area for optimal stereo imaging, the angled baffle also lets you install it horizontally above or below the TV screen, ensuring that all center channel audio is pointed in the right direction – toward the listener.

As front stage left, right, center – or rear channel surround – all three Elios Cinema In-Wall models shine in any home theater application.



E552W



E532W

	E752W	E552W	E532W
System Type	Dual Woofer L / R	Dual Woofer L / C / R	Dual Woofer L / C / R
Woofer	7 in. woven Kevlar (2)	5.25 in. woven Kevlar (2)	5.25 in. mica-filled injection cone (2)
Tweeter	1 in. Titanium / Aluminum nano-coated Teteron dome, pivoting	1 in. Titanium / Aluminum nano-coated Teteron dome, pivoting	1 in. Teteron dome, pivoting
Frequency Response	40Hz-20kHz	50Hz-20kHz	50Hz-20kHz
Sensitivity	90dB	88dB	88dB
Rated Power	90W RMS	80W RMS	80W RMS
Nominal Impedance	6 Ohms	6 Ohms	6 Ohms
Crossover	Custom “Q” multi-pole	Custom “Q” multi-pole	Custom “Q” multi-pole
Switches	Bass & EQ	Bass & EQ	Bass & EQ
Cutout Dims.	9-1/2 W x 19 H in. (241 W x 483 H mm)	7-1/4 W x 14-3/8 H in. (184 W x 365 H mm)	7-1/4 W x 14-3/8 H in. (184 W x 365 H mm)
Outside Frame Dims.	10-3/4 W x 20-1/4 H in. (273 W x 514 H mm)	8-3/8 W x 15-7/16 H in. (231 W x 392 H mm)	8-3/8 W x 15-7/16 H in. (231 W x 392 H mm)
Depth	4 in. (102mm)	4 in. (102 mm)	4 in. (102 mm)
Rough-in Brackets	BKT77W	BKT55W	BKT55W

ELIOS CINEMA SPEAKERS continued

Elios E650S

The E650S's unique, patent-pending design utilizes a 6.5-inch woven Kevlar woofer aimed directly outward for maximum bass dispersion. Opposing midrange and tweeter banks are aimed away from the listener at angles of 30 degrees off the woofer's acoustic axis, splitting and focusing the sound field away from the listener to create the diffuse ambient sound required for surround sound technologies.

Unlike conventional dipoles, which utilize dual woofers mounted on the same acoustical planes as the midrange driver and tweeter, the E650S's single

forward-firing 6.5 inch woofer not only allows a much smaller size, but practically eliminates the chance for low frequency interference between the lower midrange and upper bass frequencies.

The results are a combination of clean, tight bass and smooth, perfectly-focused mids and highs that are ideal for surround sound signal reproduction.



E650S

E650S

System Type	3-way dipole
Woofer	6-1/2 in. woven Kevlar fiber cone rubber surround, cast frame
Midrange	2.5 in. Mica-filled injection cone
Tweeter	2 x .75 in. woven Kevlar dome, fluid cooling, rear wave damping, neo magnet
Frequency Response	50Hz-22kHz
Sensitivity	87dB
Rated Power	75W RMS
Nominal Impedance	6 Ohms
Crossover	2nd order Custom "Q" @ 300Hz & 6kHz
Switches	EQ switch (bright, neutral & warm) phase
Cutout Dims.	7-1/4 W x 14 3/8 H in. (184 W x 365 H mm)
Outside Frame Dims.	8-3/8 W x 15-7/16 H in. (213 W x 392 H mm)
Depth	4 in. (102 mm)
Rough-in Brackets	BKT55W





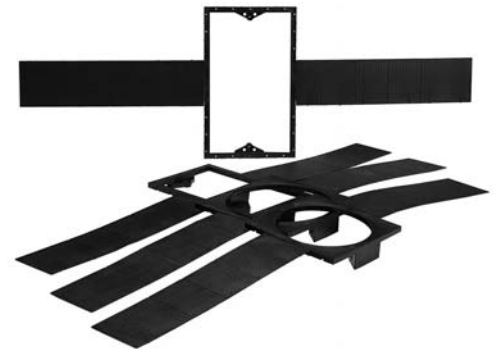











































ELIOS ROUGH-IN SPEAKER BRACKETS

Bracket No. (sold in 6 pks)	BKT7C	BKT7PC	BKT9C	BKT9PC	BKT7W	BKT55W	BKT77W
For use with Speaker Order No.	E70C E71C E72C E72D	E73C E74C E75C E73D	E91C E92C	E93C E94C E95C	E71W E72W	E532W E552W E650S	E752W



ELIOS / M SERIES / THEATERPOINT COMPARISON CHART

NOTE: Equivalences are based on similarity of price points and/or applications. With the exception of the E650S/THP650D In-Wall Dipole Surround Sound Speakers, hole cutout dimensions and rough-in bracket sizes are NOT the same.

Elios model	M Series Equivalent(s)	Elios model	M Series / THP Equivalent(s)
 E70C	 MC650C	 E91C	 ME800C /  THP801C
 E71C	 MC650C /  ME650C	 E92C	 MM800C /  THP802C
 E72C	 ME650C	 E93C	 MM800C /  THP802C
 E73C	 MM650C	 E94C	 MP800C
 E74C	 MM650C /  MP650C	 E95C	 THP803C
 E75C	 MP650C		
 E72D	 MM650D	 E532W	 MM525W /  THP525W
 E73D	 MP800D	 E552W	 MP525W /  THP525W
 E71W	 MC650W /  ME650W	 E752W	 MM800W /  MP800W /  THP650W
 E72W	 MM650W /  MP650W	 E650S	 THP650D

Life Just Got Better.®



voice 859.269.7760 **fax** 859.269.7972 **sales** 877.BUY.ELAN(877.289.3526) **tech support** 800.622.3526
internet www.elanhomesystems.com **email** elan@elanhomesystems.com

© ELAN Home Systems • 2009 • All rights reserved • ELAN is a registered trademark of ELAN Home Systems. Elios is a trademark of ELAN Home Systems

P/N: ELIOS_Retail_Ref_Book_041609